

Idea3399 Reference User Manual

V2. 201907

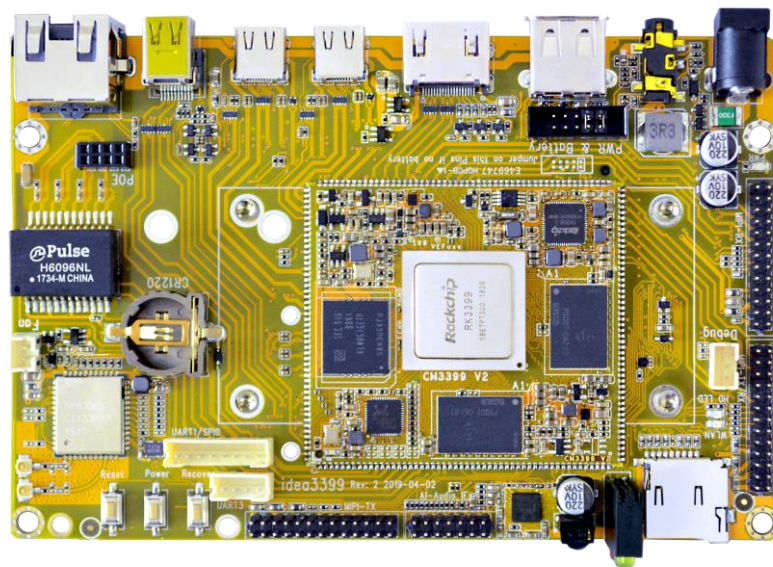

Boardcon Embedded Design

www.boardcon.com

1. Introduction

1.1. About this Manual

This manual is intended to provide the user with an overview of the board and benefits, complete features specifications, and set up procedures. It contains important safety information as well.

1.2. Feedback and Update to this Manual

To help our customers make the most of our products, we are continually making additional and updated resources available on the Boardcon website (www.boardcon.com , www.armdesigner.com).

These include manuals, application notes, programming examples, and updated software and hardware. Check in periodically to see what's new!

When we are prioritizing work on these updated resources, feedback from customers is the number one influence, If you have questions, comments, or concerns about your product or project, please no hesitate to contact us at support@armdesigner.com.

1.3. Limited Warranty

Boardcon warrants this product to be free of defects in material and workmanship for a period of one year from date of buy. During this warranty period Boardcon will repair or replace the defective unit in accordance with the following process:

A copy of the original invoice must be included when returning the defective unit to Boardcon. This limited warranty does not cover damages resulting from lightning or other power surges, misuse, abuse, abnormal conditions of operation, or attempts to alter or modify the function of the product.

This warranty is limited to the repair or replacement of the defective unit. In no event shall Boardcon be liable or responsible for any loss or damages, including but not limited to any lost profits, incidental or consequential damages, loss of business, or anticipatory profits arising from the use or inability to use this products.

Repairs make after the expiration of the warranty period are subject to a repair charge and the cost of return shipping. Please contact Boardcon to arrange for any repair service and to obtain repair charge information.



Content

1 Idea3399 Introduction	3
1.1 Summary	3
1.2 Rockchip RK3399 Features	3
1.3 Idea3399 Specifications	4
1.4 PCB Dimension.....	5
1.5 Block Diagram.....	6
1.6 Motherboard Power meter	6
1.7 CPU Introduction.....	7
2 Peripherals Introduction	15
2.1 Power.....	15
2.2 Audio I/O (J9, J8)	17
2.3 USB Host (USB1)	18
2.4 HDMI OUT (J5)	18
2.5 USB Type-C (J10, J11)	19
2.6 miniDP (J7)	20
2.7 Ethernet (JP1).....	21
2.8 POE (J32)	22
2.9 Fan (J2)	22
2.10 UART1/SPI0, UART3 (J13, J12).....	22
2.11 Keys (K1, K2, K3, KEY3).....	23
2.12 MIPI_DSI(CON1)	24
2.13 MIPI Camera(CON4, CON5).....	25
2.14 Debug (J4)	26
2.15 4G & SIM (CON2, P2).....	27
2.16 SATA (CON3).....	29
2.17 Micro SD (J1)	30
2.18 WiFi&Bluetooth (U8)	31
2.19 RTC (BT1).....	32
2.20 Infrared Receiver(U3)	33
3 Product Configurations.....	33
3.1 Standard Contents	33
3.2 Optional Parts	33

1 Idea3399 Introduction

1.1 Summary

Idea3399 is a single board computer equipped with RK3399 Cortex-A72 + Quad Cortex-A53 processor coupled with 4GB RAM, 8GB eMMC, an mPCIe slot for cellular connectivity, and other interactive interfaces geared towards AI and IoT Applications.

Display features include a mDP port, HDMI and MIPI LCD. Idea3399 adopts ALC5651 dual I2S interface audio codec that supports analog/digital input. The 2x USB3.0 Type C can be converted to HDMI/USB3.0/USB2.0. In addition, Type C0 also can be used for debugging.

The board is available with a WiFi/BT module with dual-band 802.11ac/a/b/g/n and Bluetooth 4.1 connectivity.

The Idea3399 SBC is equipped with a 4G model(optional) that delivers 100Mbps downlink and 50Mbps uplink data rates, and GSM/GPRS networks to ensure that it can connect even in remote areas devoid of 4G or 3G coverage. The model also combines high-speed wireless connectivity with embedded multi-constellation high-sensitivity positioning GPS+GLONASS receiver.

Other expansion features include a M.2 slot, 2x MIPI Cameras, MIC Array, 8-pin PoE connector, IR in, etc.

1.2 Rockchip RK3399 Features

- **Microprocessor**
 - Dual-core ARM Cortex-A72 up to 1.8G.
 - Quad-core ARM Cortex-A53 up to 1.4G.
 - 1MB unified L2 Cache for Big cluster, 512KB unified L2 Cache for Little cluster.
- **Memory Organization**
 - On board memory
 - LPDDR4 up to 4GB.
 - EMMC4.51 up to 128GB.
 - External memory.
 - SPI NOR
- **Cortex-M0**
 - Two Cortex-M0 cooperate with Cortex-A72/Cortex-A53.
 - Integrated sleep modes for low power consumption.
 - Serial Wire Debug reduces the number of pins required for debugging.
- **PWM**
 - Four on-chip PWMs with interrupt-based operation.
 - Support capture mode and continuous mode or one-shot mode.
- **Watchdog**
 - Three Watchdogs in SoC with 32 bits counter width.
- **Interrupt Controller**
 - Support 8 PPI interrupt source and 148 SPI interrupt sources input.



- Support 16 software-triggered interrupts.
- **3D Graphics Engine**
 - Arm Mali-T860MP4 GPU up to 4K supply.
 - High performance OpenGL ES1.1/2.0/3.0, OpenCL1.2, DirectX11.1 etc.
 - Provide MMU and L2 Cache with 256KB size
- **Power unit**
 - RK818 on board.
 - Compatible with multiple mode power supply.
Such as 3.7V/7.4V battery, single 3.3V DC or 3.3V/5V DC.
 - Very low RTC consume current, less 7uA at 3V button Cell.
- **Temperature**
 - Less 46° run video play (exposed board at 20°).
 - Less 60° run AnTuTu test (exposed board at 20°)

1.3 Idea3399 Specifications

Feature	Specifications
CPU	<ul style="list-style-type: none"> • Rockchip RK3399. Big.Little architecture: Dual Cortex-A72 + Quad Cortex-A53, 64-bit CPU • 28nm HKMG process • 1MB unified L2 Cache for Big cluster, 512KB unified L2 Cache for Little cluster
GPU	<ul style="list-style-type: none"> • Mali-T864 GPU, OpenGL ES1.1/2.0/3.0/3.1, OpenVG1.1, OpenCL, DX11 • Supports AFBC (ARM Frame Buffer Compression)
Memory	4GB LPDDR4
iNAND	8GB eMMC
Power	DC 5V/3A or 3.7V Li-Battery
Ethernet	1000M High performance Ethernet (RTL8211E), RJ45 interface
MINI DP	1x mini Display Port
USB	1x USB2.0 Host, 2x USB3.0 Type C
HDMI	HDMI 1.4 and 2.0, support 4K, 1080P, 720P, 480P resolution
Audio	Adopt Realtek ALC5651 Audio CODEC. 3.5mm jack for headphone; 14-pin header for MIC Array.
PWR&Battery	2x5pin connector. 3.7V Li-Battery
MIPI	3x 26-pin headers. MIPI RX for camera1, 13 Megapixels; MIPI RX/TX for camera2, 13 Megapixels; MIPI TX for MIPI LCD.
Micro SD	1x Micro SD Card slot
IR	Support IR in
UART	4-wire UART1 (Multiplexed signal with GbE), 1x 8pin connector (J13);



	3-wire UART2, 1x 3pin connector. For debug; 4-wire UART3(Multiplexed signal with GbE), 1x 4pin connector
SPI	1x 8pin connector (J13)
Buttons	4x Buttons for Recover (2x), Power and Reset
RTC	3V battery, CR1220
POE	2x4pin connector
3G/4G (optional)	52pins MINI PCI-E Socket. Support 3G/4G module
SSD(optional)	NVME SSD PCI.E X2
Camera (optional)	13 Megapixels, OV13850 model
WiFi&BT	Wireless-2.4GHz/5GHz 802.11 a/b/g/n/ac. Bluetooth 4.1
Dimension	135mm x 90mm

1.4 PCB Dimension

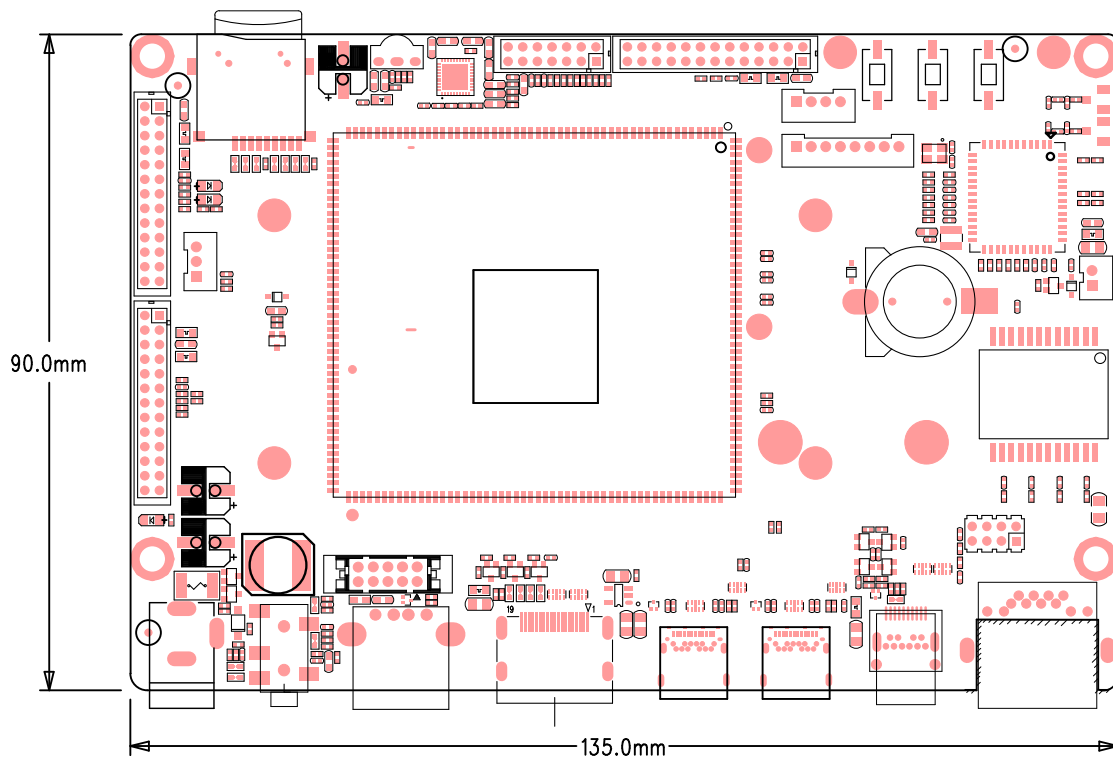

1.5 Block Diagram

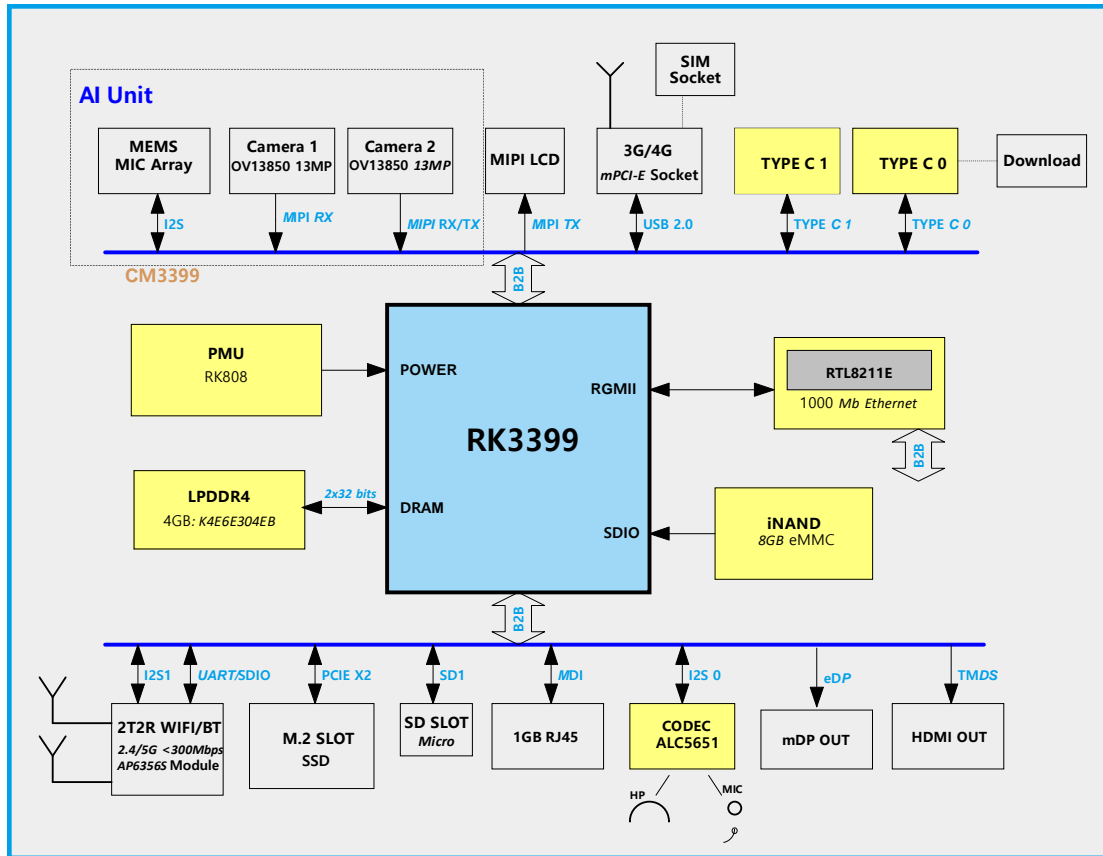

1.6 Motherboard Power meter

Power	OS	Operation Temperature °C	Connected devices	Electric current (A)
5V@3A	Android7.1.2	Normal	5V power	1.1
			Power, 10.1-inch MIPI panel	2.2
			Power, SD card, play 4K video, U-disk, USB Mouse, debug serial, Ethernet, 10.1-inch MIPI panel, headphone, WiFi&bluetooth, 4G, Fan	2.6
			Power, SD card, play AnTuTu, U-disk, USB Mouse, debug serial, Ethernet, 10.1-inch MIPI panel, headphone, WiFi&bluetooth, 4G, Fan	2.9



Pin Definition

Pin	Signal	Description	Alternate functions	IO Voltage
1	SDMMC_CMD	SDMMC card command output and response input	GPIO4_B5	3.0V
2	SDMMC0_DET_L	SDMMC card detect signal (10K Pull H)	GPIO0_A7	1.8V
3	SDMMC_D0	SDMMC card data input and output	GPIO4_B0	3.0V
4	SDMMC_D1	SDMMC card data input and output	GPIO4_B1	3.0V
5	SDMMC_D2	SDMMC card data input and output	GPIO4_B2	3.0V
6	SDMMC_D3	SDMMC card data input and output	GPIO4_B3	3.0V
7	ADKEY_IN	10bit ADC input signal (10K Pull H)	ADIN1 & Recover	1.8V
8	ADC_IN2	10bit ADC input signal	ADIN2	1.8V
9	LED1_AD1	Ethernet Speed LED(H)		3.3V
10	LED0_AD0_SPDIF-TX	ETH Link LED(L) or Spdif TX		3.3V
11	GND	GND		0V
12	MDI0+_UART1-TX	ETH MD0+ or TXD1		3.3V
13	MDI0-_UART1-RX	ETH MD0- or RXD1		3.3V
14	MDI1+_SPI0-TXD	ETH MD1+ or SPI0TXD		3.3V
15	MDI1-_SPI0-CSn0	ETH MD1- or SPI0CS0		3.3V
16	MDI2+_SPI0-CLK	ETH MD2+ or SPI0CLK		3.3V
17	MDI2-_SPI0-RXD	ETH MD2- or SPI0RXD		3.3V
18	MDI3+_UART3-TX	ETH MD3+ or TXD3		3.3V
19	MDI3-_UART3-RX	ETH MD3- or RXD3		3.3V
20	BT_HOST_WAKE_L	Bluetooth device to wake-up HOST	GPIO0_A4	1.8V
21	GPIO1_A2	GPIO		1.8V
22	WIFI_REG_ON_H	WIFI Regulators power EN	GPIO0_B2	1.8V
23	WIFI_HOST_WAKE_L	WIFI to wake-up HOST	GPIO0_A3	1.8V
24	CIF_CLKOUT	Camera main clock output	GPIO2_B3	1.8V
25	OTP_OUT_H	Over temperature	GPIO1_A6	1.8V
26	I2C4_SCL	I2C serial clock line (Need pull H)	GPIO1_B4	1.8V
27	ALRT_H	Battery Gauge IC interrupt	GPIO1_C2	1.8V
28	I2C4_SDA	I2C data line (Need pull H)	/GPIO1_B3	1.8V
29	SPI1_CSn0	SPI first chip select signal	SPI1CS /GPIO1_B2	1.8V
30	SPI1_TXD	SPI serial data output	SPI1TX /TXD4 /GPIO1_B0	1.8V
31	GPIO1_A1	GPIO		1.8V
32	BT_REG_ON_H	Bluetooth power on		1.8V
33	SPI1_CLK	SPI serial clock	SPI1CLK /GPIO1_B1	1.8V
34	SPI1_RXD	SPI serial data input	SPI1RX /RXD4 /GPIO1_A7	1.8V



Pin	Signal	Description	Alternate functions	IO Voltage
35	CIF_PDN0	CIF power ON/OFF	SPI2CS /GPIO2_B4	1.8V
36	I2C2_SCL	I2C serial clock line (Need pull H)	GPIO2_A1	1.8V
37	I2C2_SDA	I2C data line (Need pull H)	GPIO2_A0	1.8V
38	I2C6_SCL	I2C serial clock line (Need pull H)	SPI2TX /GPIO2_B2	1.8V
39	I2C6_SDA	I2C data line (Need pull H)	SPI2RX /GPIO2_B1	1.8V
40	GPIO1_A3	GPIO		1.8V
41	GPIO1_A0	GPIO		1.8V
42	PWM3_IRIN	Pulse Width Modulation output, special design for IR receiver	PWM3 /IR_IN /GPIO0_A6	1.8V
43	PCIE_WAKE#		GPIO1_B5	1.8V
44	I2C1_SCL	I2C1 Bus Clock (Need pull H)	GPIO4_A2	1.8V
45	I2C1_SDA	I2C1 Bus Data (Need pull H)	GPIO4_A1	1.8V
46	I2S1_LRCK	I2S1 LRCK input	GPIO4_A4 & GPIO4_A5	1.8V
47	I2S1_SDO0	I2S1 Data0 output	GPIO4_A7	1.8V
48	I2S_CLK	I2S clock	GPIO4_A0	1.8V
49	I2S1_SDI0	I2S serial data input	GPIO4_A6	1.8V
50	I2S1_SCLK	I2S serial clock	GPIO4_A3	1.8V
51	I2S0_LRCK	I2S left & right channel signal for receiving/ transmitting serial data	GPIO3_D1 & GPIO3_D2	1.8V
52	I2S0_SCLK	I2S serial clock	GPIO3_D0	1.8V
53	I2S0_SDO0	I2S serial data output	GPIO3_D7	1.8V
54	I2S0_SDO1	I2S serial data output	GPIO3_D6	1.8V
55	I2S0_SDO2	I2S serial data output	GPIO3_D5	1.8V
56	I2S0_SDO3	I2S serial data output	GPIO3_D4	1.8V
57	I2S0_SDI0	I2S serial data input	GPIO3_D3	1.8V
58	LCD_BL_PWM	Backlight PWM output	PWM0 /GPIO4_C2	3.0V
59	PCIE_PRSTNT		GPIO4_D6	3.0V
60	UART2DBG_RX	Debug UART RXD	RXD2 /GPIO4_C3	3.0V
61	UART2DBG_TX	Debug UART TXD	TXD2 /GPIO4_C4	3.0V
62	I2C_SCL_HDMI	I2C clock line for HDMI	I2C3_SCL /GPIO4_C1	3.0V
63	I2C_SDA_HDMI	I2C data line for HDMI	I2C3_SDA /GPIO4_C0	3.0V
64	3V_GPIO4_D4	GPIO		3.0V
65	PCIE_PERST#	Power reset	GPIO4_D5	3.0V
66	3V_GPIO4_C5	GPIO	GPIO4_C5	3.0V



Pin	Signal	Description	Alternate functions	IO Voltage
			/SPDIF_TX	
67	3V_GPIO4_D2	GPIO		3.0V
68	TOUCH_RST_L	Touch screen reset	GPIO4_C6/PWM1	3.0V
69	3V_GPIO4_D0	GPIO	PCIE_CLKREQnB	3.0V
70	HDMI_CEC	HDMI CEC signal	GPIO4_C7	3.0V
71	3V_GPIO4_D3	GPIO		3.0V
72	3V_GPIO4_D1	GPIO		3.0V
73	GND	GND		0V
74	SDIO0_CLK	SDIO card clock	GPIO2_D1	1.8V
75	SDIO0_CMD	SDIO card command output and response input	GPIO2_D0	1.8V
76	SDIO0_D0	SDIO card data input and output	/SPI5RX /GPIO2_C4	1.8V
77	SDIO0_D1	SDIO card data input and output	/SPI5TX /GPIO2_C5	1.8V
78	SDIO0_D2	SDIO card data input and output	/SPI5CLK /GPIO2_C6	1.8V
79	SDIO0_D3	SDIO card data input and output	/SPI5CS /GPIO2_C7	1.8V
80	BT_WAKE_L	HOST wake-up Bluetooth device	SDIO0_DET /GPIO2_D2	1.8V
81	UART0_RXD	UART serial data input	GPIO2_C0	1.8V
82	UART0_RTS	UART request to send	GPIO2_C3	1.8V
83	UART0_CTS	UART clear to send	GPIO2_C2	1.8V
84	UART0_TXD	UART serial data output	GPIO2_C1	1.8V
85	HDMI_HPD	HDMI hot plug detect signal (Single function)		3.3V
86	TYPEC0_ID	USB 2.0 OTG ID detection (Single function)		3.3V
87	POWER_KEY	Key input (Single function)		5V
88	Reset_KEY	Key input (Single function)		5V
89	PMIC_EXT_EN	EXT-DCDC enable (Single function)		5V
90	GND	GND		0V
91	MIPI_TX/RX_D0P	MIPI CSI positive differential data line transceiver output		1.8V
92	MIPI_TX/RX_D0N	MIPI CSI negative differential data line transceiver output		1.8V
93	MIPI_TX/RX_D1P	MIPI CSI positive differential data line transceiver output		1.8V
94	MIPI_TX/RX_D1N	MIPI CSI negative differential data line transceiver output		1.8V



Pin	Signal	Description	Alternate functions	IO Voltage
95	MIPI_TX/RX_CLKP	MIPI CSI positive differential clock line transceiver output		1.8V
96	MIPI_TX/RX_CLKN	MIPI CSI negative differential clock line transceiver output		1.8V
97	MIPI_TX/RX_D2P	MIPI CSI positive differential data line transceiver output		1.8V
98	MIPI_TX/RX_D2N	MIPI CSI negative differential data line transceiver output		1.8V
99	MIPI_TX/RX_D3P	MIPI CSI positive differential data line transceiver output		1.8V
100	MIPI_TX/RX_D3N	MIPI CSI negative differential data line transceiver output		1.8V
101	GND	GND		0V
102	VCC_SYS	Main power input		3.3V-5V
103	VCC_SYS	Main power input		3.3V-5V
104	VCC3V3_SYS	VCC_IO input (Pin89 control)		3.3V
105	VCC3V3_SYS	VCC_IO input (Pin89 control)		3.3V
106	GND	GND		0V
107	RTC_CLKO_WIFI	RTC CLK output for WiFi32.768KHz		1.8V
108	VCCA1V8_CODEC	Codec Power output (200mA)		1.8V
109	VBuck	PMU start power (Connect VCC_SYS or before than it)		3.3V-5V
110	VCC_RTC	Button Cell input (If not need, NC)		1.8V-3.3V
111	VCC3V3_S0	LCD Power output (350mA)		3.3V
112	VCCA3V0_CODEC	Codec Power output (300mA)		3.0V
113	VCC1V8_DVP	Camera IO Power out (80mA)		1.8V
114	VCC3V0_TOUCH	Touch panel Power (150mA)		3.0V
115	MIPI_TX_D3N	MIPI DSI negative differential data line transceiver output	DSI	1.8V
116	MIPI_TX_D3P	MIPI DSI positive differential data line transceiver output	DSI	1.8V
117	MIPI_TX_D2N	MIPI DSI negative differential data line transceiver output	DSI	1.8V
118	MIPI_TX_D2P	MIPI DSI positive differential data line transceiver output	DSI	1.8V
119	MIPI_TX_CLKN	MIPI DSI negative differential clock line transceiver output	DSI	1.8V
120	MIPI_TX_CLKP	MIPI DSI positive differential clock line transceiver output	DSI	1.8V
121	MIPI_TX_D1N	MIPI DSI negative differential data line transceiver output	DSI	1.8V



Pin	Signal	Description	Alternate functions	IO Voltage
122	MIPI_TX_D1P	MIPI DSI positive differential data line transceiver output	DSI	1.8V
123	MIPI_TX_D0N	MIPI DSI negative differential data line transceiver output	DSI	1.8V
124	MIPI_TX_D0P	MIPI DSI positive differential data line transceiver output	DSI	1.8V
125	GND	GND		0V
126	MIPI_RX_D3P	MIPI CSI positive differential data line transceiver output	CSI	1.8V
127	MIPI_RX_D3N	MIPI CSI negative differential data line transceiver output	CSI	1.8V
128	MIPI_RX_D2P	MIPI CSI positive differential data line transceiver output	CSI	1.8V
129	MIPI_RX_D2N	MIPI CSI negative differential data line transceiver output	CSI	1.8V
130	MIPI_RX_CLKP	MIPI CSI positive differential clock line transceiver output	CSI	1.8V
131	MIPI_RX_CLKN	MIPI CSI negative differential clock line transceiver output	CSI	1.8V
132	MIPI_RX_D1P	MIPI CSI positive differential data line transceiver output	CSI	1.8V
133	MIPI_RX_D1N	MIPI CSI negative differential data line transceiver output	CSI	1.8V
134	MIPI_RX_D0P	MIPI CSI positive differential data line transceiver output	CSI	1.8V
135	MIPI_RX_D0N	MIPI CSI negative differential data line transceiver output	CSI	1.8V
136	GND	GND		0V
137	TX_C-	HDMI TXC-		1.8V
138	TX_C+	HDMI TXC+		1.8V
139	TX_0-	HDMI TXD0-		1.8V
140	TX_0+	HDMI TXD0+		1.8V
141	TX_1-	HDMI TXD1-		1.8V
142	TX_1+	HDMI TXD1+		1.8V
143	TX_2-	HDMI TXD2-		1.8V
144	TX_2+	HDMI TXD2+		1.8V
145	GND	GND		0V
146	TYPECO_AUXP	AUX differential Tx serial data		1.8V
147	TYPECO_AUXM	AUX differential Rx serial data		1.8V
148	TYPECO_RX1P	Receiver serial data +		1.8V
149	TYPECO_RX1N	Receiver serial data -		1.8V



Pin	Signal	Description	Alternate functions	IO Voltage
150	TYPEC0_TX1N	Transmitter serial data -		1.8V
151	TYPEC0_TX1P	Transmitter serial data +		1.8V
152	TYPEC0_TX2P	Transmitter serial data +		1.8V
153	TYPEC0_TX2N	Transmitter serial data -		1.8V
154	GND	GND		0V
155	TYPEC0_DP	USB 2.0 data DP		1.8V
156	TYPEC0_DM	USB 2.0 data DN		1.8V
157	TYPEC0_RX2N	Receiver serial data -		1.8V
158	TYPEC0_RX2P	Receiver serial data+		1.8V
159	VBUS_TYPEC0	VBUS BUMP into the PHY for VBUS monitor		5V-12V
160	TYPEC1_DM	USB 2.0 data DN		1.8V
161	TYPEC1_DP	USB 2.0 data DP		1.8V
162	TYPEC1_U2VBUSDET	VBUS BUMP into the PHY for VBUS monitor		3.3V
163	HOST1_DP	USB 2.0 data DP		1.8V
164	HOST1_DM	USB 2.0 data DN		1.8V
165	GND	GND		0V
166	TYPEC1_TX1P	Transmitter serial data +		1.8V
167	TYPEC1_TX1N	Transmitter serial data -		1.8V
168	TYPEC1_RX2N	Receiver serial data -		1.8V
169	TYPEC1_RX2P	Receiver serial data+		1.8V
170	TYPEC1_RX1P	Receiver serial data+		1.8V
171	TYPEC1_RX1N	Receiver serial data -		1.8V
172	TYPEC1_TX2P	Transmitter serial data +		1.8V
173	TYPEC1_TX2N	Transmitter serial data -		1.8V
174	TYPEC1_AUXM	AUX differential Tx serial data		1.8V
175	TYPEC1_AUXP	AUX differential Rx serial data		1.8V
176	GND	GND		0V
177	PCIE_RX1_P	PCIe differential data input signal +		1.8V
178	PCIE_RX1_N	PCIe differential data input signal -		1.8V
179	PCIE_TX1P	PCIe differential data output signal +		1.8V
180	PCIE_TX1N	PCIe differential data output signal -		1.8V
181	PCIE_RX0_P	PCIe differential data input signal +		1.8V
182	PCIE_RX0_N	PCIe differential data input signal -		1.8V
183	PCIE_TX0P	PCIe differential data output signal +		1.8V
184	PCIE_TX0N	PCIe differential data output signal -		1.8V
185	PCIE_REF_CLKN	Reference clock -		1.8V
186	PCIE_REF_CLKP	Reference clock +		1.8V
187	GND	GND		0V
188	HOST0_DP	USB host 0 data +		1.8V



Pin	Signal	Description	Alternate functions	IO Voltage
189	HOST0_DM	USB host 0 data -		1.8V
190	GND	GND		0V
191	eDP_TX3P	eDP data lane output +	Capacitor on core board	1.8V
192	eDP_TX3N	eDP data lane output -	Capacitor on core board	1.8V
193	eDP_TX2P	eDP data lane output +	Capacitor on core board	1.8V
194	eDP_TX2N	eDP data lane output -	Capacitor on core board	1.8V
195	eDP_TX1P	eDP data lane output +	Capacitor on core board	1.8V
196	eDP_TX1N	eDP data lane output -	Capacitor on core board	1.8V
197	eDP_TX0P	eDP data lane output +	Capacitor on core board	1.8V
198	eDP_TX0N	eDP data lane output -	Capacitor on core board	1.8V
199	eDP_AXUP	eDP CH-AUX differential output +		1.8V
200	eDP_AXUN	eDP CH-AUX differential output -		1.8V
201	GND	GND		0V
202	SDMMC_CLK	SDMMC card clock	GPIO4_B4	3.0V

2 Peripherals Introduction

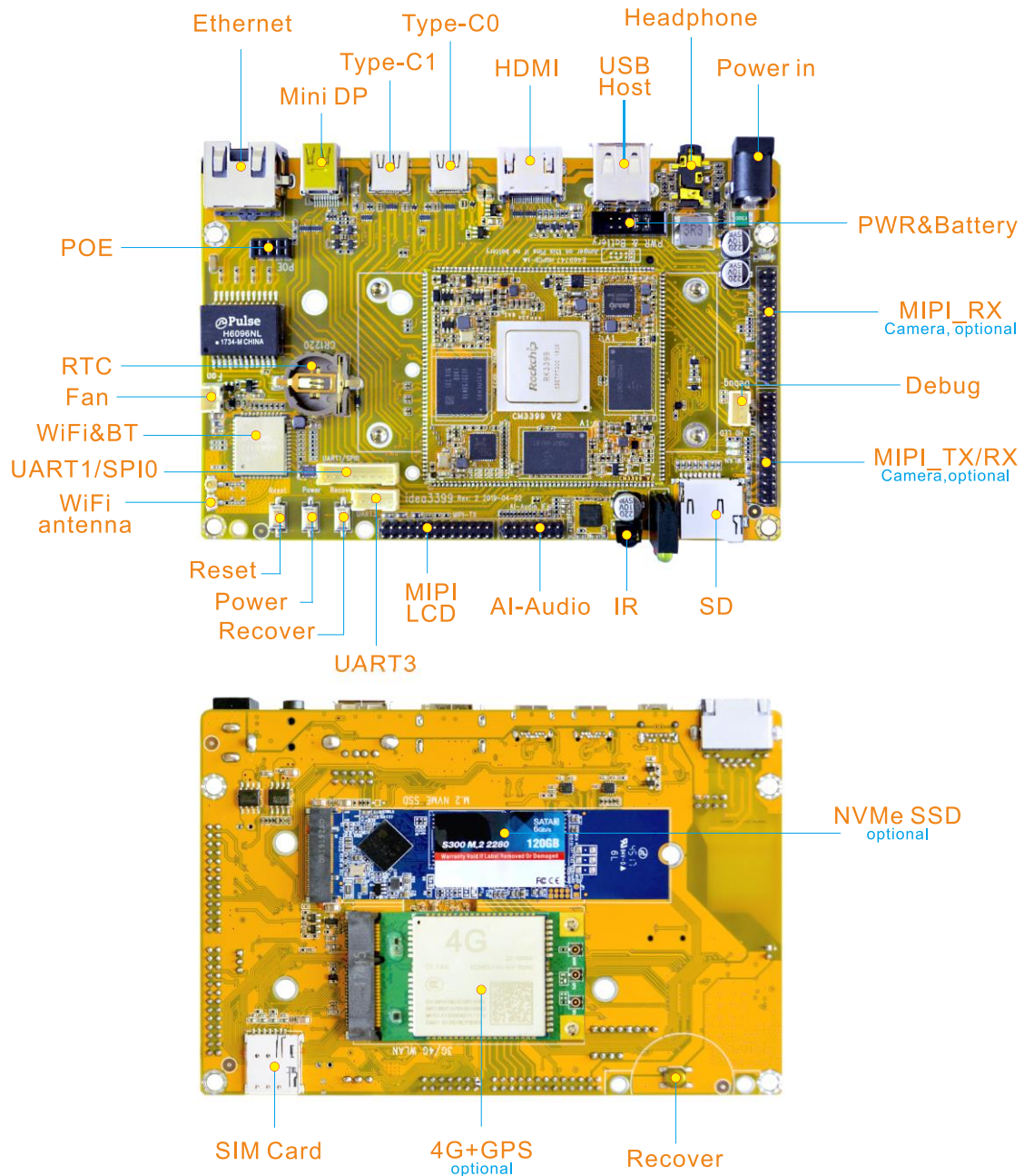

2.1 Power

Idea3399 Power – 5V via DC jack + battery header for Lithium battery.

- **5V/3A DC power supply (P1)**

Jumper short Pin9&10 of **Header J3** if only powered by the power adapter.

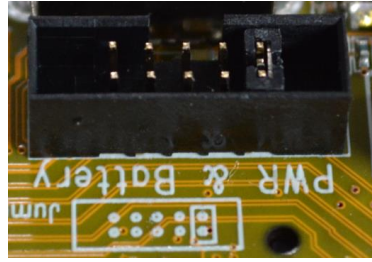

J3

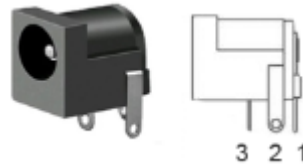

P1

P1					
Pin	Signal	Description	Pin	Signal	Description
1	VDD5V	Main power supply. DC 5V power in	2	GND	Ground
3	GND	Ground			

• **Li-ion battery (J3)**

Idea3399 Battery: 3.7V

The Li-ion battery connector is a 10-pin header(J3).

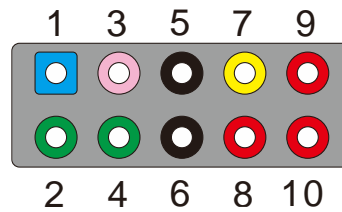
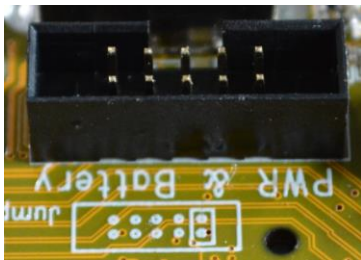

J3					
Pin	Signal	Description	Pin	Signal	Description
1	SPI1_RXD	SPI serial data input	2	I2C4_SCL	I2C serial clock line
3	ALRT_H	Battery Gauge IC interrupt	4	I2C4_SDA	I2C data line
5	GND	Ground	6	GND	Ground
7	VBUS_TYPEC0	VBUS BUMP into the PHY for VBUS monitor	8	VCC_SYS	Main power input
9	VDD5V	DC5V	10	VCC_SYS	Main power input

2.2 Audio I/O (J9, J8)



J9

The Idea3399 adopts Realtek ALC5651, provides stereo audio output (J9, PJ327E, 3.5mm Jack). In addition, an AI-Audio interface(J8) is also provided.

Features

- Low power
- Integrated ADC and DAC
- IIS transfer audio data
- Stereo output, support recording

J9					
Pin	Signal	Description	Pin	Signal	Description
1	GND	Ground	2	HPO_R	Headphone amplifier output _Right channel
3	HPO_L	Headphone amplifier output _Left channel	4	PHE_DET	Headphone Detect
5	MIC2	Single-end input for microphone			

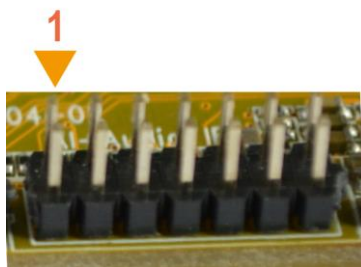

J8 AI-Audio

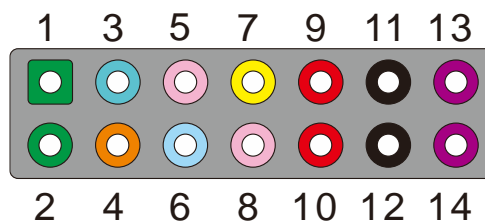

J8 pinout					
Pin	Signal	Description	Pin	Signal	Description
1	I2C1_SCL	I2C serial clock line	2	I2C1_SDA	I2C data line
3	BCLK2	Serial bit clock	4	I2S_CLK	I2S clock
5	DACDAT2	Serial data input	6	LRCK2	Synchronous signal
7	MIC_RST	MIC reset	8	ADCDAT2	Serial data output
9	VCCA3V0_	Analog power for MICBIAS,	10	VCCA1V8	Analog power, 1.8V

	CODEC	3.3V		_CODEC	
11	GND	Ground	12	GND	Ground
13	ROUTP	Right channel output	14	LOUTP	Left channel output

2.3 USB Host (USB1)



Idea3399 provides 1x USB2.0 Host to connect USB mouse, U disk, USB camera, or other USB devices. supports hot-plug.

Feature

- * Compatible with USB Host2.0 specification
- * Supports high-speed (480Mbps), full-speed (12Mbps) and low-speed (1.5Mbps) mode
- * Supports automatic switching between bus- and self-powered modes
- * Support periodic out channel in host mode

Pin	Signal	Description	Pin	Signal	Description
1	VCC_USB	USB power. DC 5V	2	HOST0_DM	USB 2.0 data DN
3	HOST0_DP	USB 2.0 data DP	4	GND	Ground

2.4 HDMI OUT (J5)

Idea3399 HDMI2.0 supports maximum 4Kx2K display, and it also enables HDMI/LCD audio and video synchronization output. The HDMI interface is the regular 19pins HDMI type A, with width 13.9mm and thickness 4.45mm. The resolution up to 1920x1080p@60HZ.

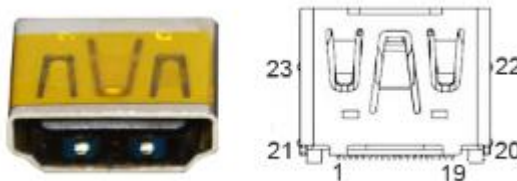

Pin	Signal	Description	Pin	Signal	Description
1	TX_2+	HDMI data 2 pair	2	GND	Ground

3	TX_2-		4	TX_1+	HDMI data 1 pair
5	GND	Ground	6	TX_1-	
7	TX_0+	HDMI data 0 pair	8	GND	Ground
9	TX_0-		10	TX_C+	HDMI clock pair
11	GND	Ground	12	TX_C-	
13	HDMI_CEC	Consumer electronics control	14	NC	Not connect
15	HDMI_SCL	HDMI serial clock	16	HDMI_SDA	HDMI serial data
17	GND	Ground	18	HDMI_VCC	5V
19	HDMI_HPD	Hot Plug Detect	20	GND	Ground
21	GND	Ground	22	GND	Ground
23	GND	Ground			

Note: If insert HDMI, The audio default output from HDMI, the headphone no voice. Plug out the HDMI cable the headphone output audio.

2.5 USB Type-C (J10, J11)

The USB3.0 Type-C0 is used to download image and ADB transfer file, or use a docking station to connect HDMI, USB device.

The Type-C1 is used to connect USB device.

Feature

- Compliant with USB Type-C Specification, revision 1.1
- Compliant with USB Power Delivery Specification, revision 2.0
- Support USB3.0 Type-C and DisplayPort1.3 Alt Mode on USB Type-C
- Up to 5Gbps data rate for USB3.0
- Up to 5.4Gbps(HBR2) data rate for DP1.2, can support 1/2/4 lane mode

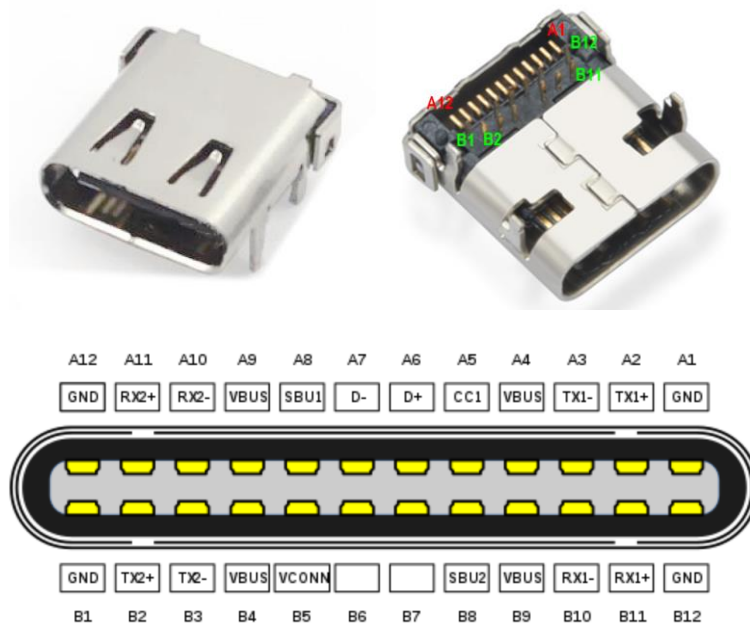

USB Type-C plug pinout end-on view



J10					
Pin	Signal	Description	Pin	Signal	Description
A1	GND	Ground	B1	GND	Ground
A2	TYPEPEC0_TX1P	Transmitter serial data +	B2	TYPEPEC0_TX2P	Transmitter serial data +
A3	TYPEPEC0_TX1N	Transmitter serial data -	B3	TYPEPEC0_TX2N	Transmitter serial data -
A4	VBUS_TYPEPEC0	VBUS BUMP into the PHY for VBUS monitor	B4	VBUS_TYPEPEC0	VBUS BUMP into the PHY for VBUS monitor
A5	TYPEPEC_CC1	Channel Configuration	B5	TYPEPEC_CC2	Channel Configuration
A6	TYPEPEC0_DP	USB 2.0 data DP	B6	TYPEPEC0_DP	USB 2.0 data DP
A7	TYPEPEC0_DM	USB 2.0 data DN	B7	TYPEPEC0_DM	USB 2.0 data DN
A8	TYPEPEC0_AUXP	AUX differential Tx serial data	B8	TYPEPEC0_AUXM	AUX differential Tx serial data
A9	VBUS_TYPEPEC0	VBUS BUMP into the PHY for VBUS monitor	B9	VBUS_TYPEPEC0	VBUS BUMP into the PHY for VBUS monitor
A10	TYPEPEC0_RX2N	Receiver serial data -	B10	TYPEPEC0_RX1N	Receiver serial data -
A11	TYPEPEC0_RX2P	Receiver serial data+	B11	TYPEPEC0_RX1P	Receiver serial data+
A12	GND	Ground	B12	GND	Ground
J11					
Pin	Signal	Description	Pin	Signal	Description
A1	GND	Ground	B1	GND	Ground
A2	TYPEPEC1_TX1P	Transmitter serial data +	B2	TYPEPEC1_TX2P	Transmitter serial data +
A3	TYPEPEC1_TX1N	Transmitter serial data -	B3	TYPEPEC1_TX2N	Transmitter serial data -
A4	VBUS_TYPEPEC1	VBUS BUMP into the PHY for VBUS monitor	B4	VBUS_TYPEPEC1	VBUS BUMP into the PHY for VBUS monitor
A5	TYPEPEC1_CC1	Channel Configuration	B5	TYPEPEC1_CC2	Channel Configuration
A6	TYPEPEC1_DP	USB 2.0 data DP	B6	TYPEPEC1_DP	USB 2.0 data DP
A7	TYPEPEC1_DM	USB 2.0 data DN	B7	TYPEPEC1_DM	USB 2.0 data DN
A8	TYPEPEC1_AUXP	AUX differential Tx serial data	B8	TYPEPEC1_AUXM	AUX differential Tx serial data
A9	VBUS_TYPEPEC1	VBUS BUMP into the PHY for VBUS monito	B9	VBUS_TYPEPEC1	VBUS BUMP into the PHY for VBUS monitor
A10	TYPEPEC1_RX2N	Receiver serial data -	B10	TYPEPEC1_RX1N	Receiver serial data -
A11	TYPEPEC1_RX2P	Receiver serial data+	B11	TYPEPEC1_RX1P	Receiver serial data+
A12	GND	Ground	B12	GND	Ground

2.6 miniDP (J7)

DisplayPort transmits video signals while adding high-definition audio signals.

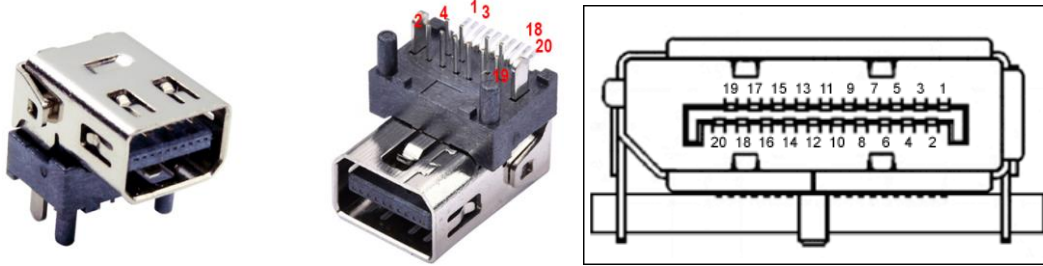

J7					
Pin	Signal	Description	Pin	Signal	Description
1	EDP_TX0P	eDP data lane output +	2	GND	Ground
3	EDP_TX0N	eDP data lane output -	4	EDP_TX1P	eDP data lane output +
5	GND	Ground	6	EDP_TX1N	eDP data lane output -
7	EDP_TX2P	eDP data lane output +	8	GND	Ground
9	EDP_TX2N	eDP data lane output -	10	EDP_TX3P	eDP data lane output +
11	GND	Ground	12	EDP_TX3N	eDP data lane output -
13	GND	Ground	14	NC	Not connect
15	EDPAXUP	eDP CH-AUX differential output +	16	GND	Ground
17	EDPAXUN	eDP CH-AUX differential output -	18	DP_HPD	Hot plug detect
19	GND	Ground	20	MDP_VCC	DC 3.3V

2.7 Ethernet (JP1)

Idea3399 adopts RTL8211E as the Ethernet chip. RJ45 connector (offset).

Feature

- * Supports 10/100/1000-Mbps data transfer rates with the RGMII interfaces
- * Supports both full-duplex and half-duplex operation
- * Supports IEEE 802.1Q VLAN tag detection for reception frames

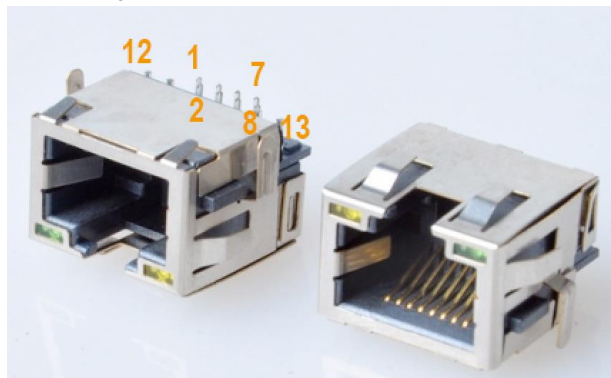

Pin	Signal	Description	Pin	Signal	Description
1	DA+	Bi-directional transmit/receive pair A	2	DA-	Bi-directional transmit/receive pair A

3	DB+	Bi-directional transmit/receive pair B	4	DC+	Bi-directional transmit/receive pair C
5	DC-	Bi-directional transmit/receive pair C	6	DB-	Bi-directional transmit/receive pair B
7	DD+	Bi-directional transmit/receive pair D	8	DD-	Bi-directional transmit/receive pair D
9	GND	Ground	10	GND	Ground
11	SPEED	Detect speed	12	GND	Ground
13	VCC3V3_SYS	DC 3.3V	14	LINK	Detect link

2.8 POE (J32)

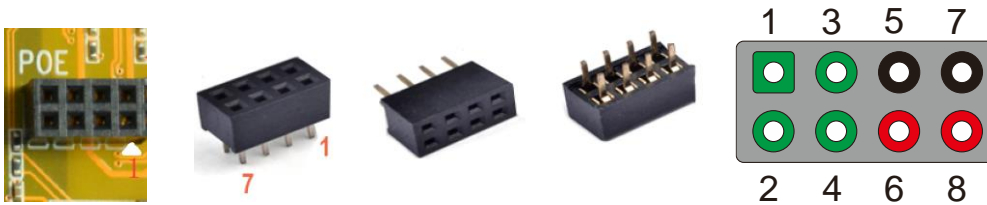

Pin	Signal	Description	Pin	Signal	Description
1	CTB	MTC2	2	CTC	MTC3
3	CTD	MTC4	4	CTA	MTC1
5	POE_GND	Ground	6	DCIN	VDD 5V
7	POE_GND	Ground	8	DCIN	VDD 5V

2.9 Fan (J2)



Pin	Signal	Description	Pin	Signal	Description
1	SPI1_CS _n 0	SPI chip select	2	VDD5V	DC 5V

2.10 UART1/SPI0, UART3 (J13, J12)

It support auto flow control mode for UART0 and UART3

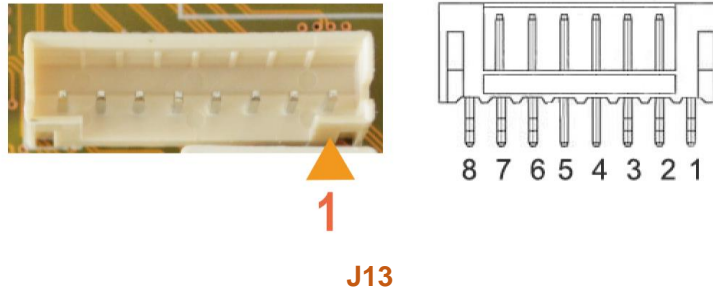

J13					
Pin	Signal	Description	Pin	Signal	Description
1	VCC3V3_S YS	DC 3V	5	MDI1-_SPI 0-CSn0	Chip select
2	MDI0+_UA RT1-TX	Transmitter serial data	6	MDI2+_SP I0-CLK	Serial clock
3	MDI0-_UAR T1-RX	Receiver serial data	7	MDI2-_SPI 0-RXD	Serial data input
4	MDI1+_SPI 0-TXD	Serial data output	8	GND	Ground

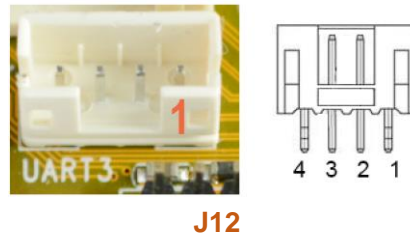

J12					
Pin	Signal	Description	Pin	Signal	Description
1	VCC3V3_S YS	DC 3V	3	MDI3-_UA RT3-RX	Receiver serial data
2	MDI3+_UA RT3-TX	Transmitter serial data	4	GND	Ground

2.11 Keys (K1, K2, K3, KEY3)

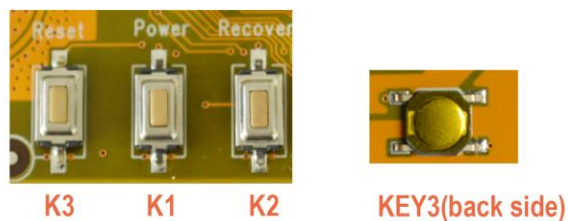

Pin	Signal	Description	Pin	Signal	Description
K1	POWER_KEY	Power	K2	ADKEY_IN	Recover
K3	Reset_KEY	Reset	KEY3	ADKEY_IN	Recover

2.12 MIPI_DSI(CON1)

It is a 26-pin header connector for MIPI panel.

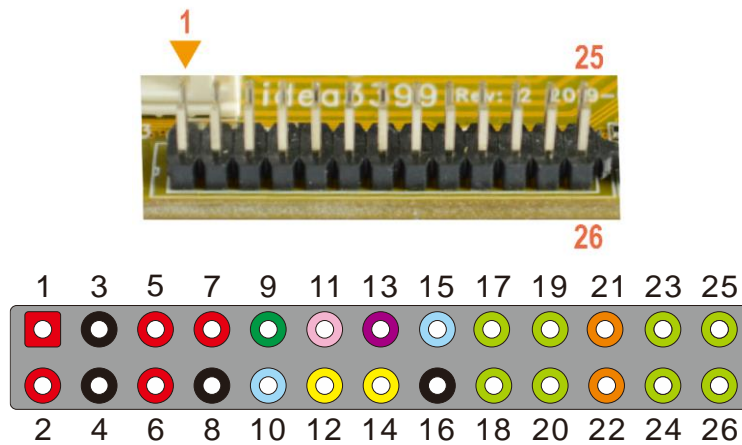

Pin	Signal	Description	Pin	Signal	Description
1	VDD5V	DC 5V	2	VDD5V	DC 5V
3	GND	Ground	4	GND	Ground
5	VCC3V3_SYS	DC 3.3V	6	VCC3V3_SYS	DC 3.3V
7	VDD1V8_DVP	DC 1.8V	8	GND	Ground
9	LCD_BL_PWM	Backlight PWM output	10	3V_GPIO4_D2	3V GPIO
11	SPDIF_TX	S/PDIF biphas data output	12	I2C6_SCL	I2C serial clock line
13	I2C6_SDA	I2C data line	14	TOUCH_RST_L	Touch screen reset
15	GPIO3_D4	1.8V GPIO	16	GND	Ground
17	MIPI_TX_D0N	Transceiver output -	18	MIPI_TX_D0P	Transceiver output +
19	MIPI_TX_D1N	Transceiver output -	20	MIPI_TX_D1P	Transceiver output +
21	MIPI_TX_CLKN	MIPI DSI negative differential clock line transceiver output	22	MIPI_TX_CLKP	MIPI DSI positive differential clock line transceiver output
23	MIPI_TX_D2N	MIPI DSI negative differential data line transceiver output	24	MIPI_TX_D2P	MIPI DSI positive differential data line transceiver output
25	MIPI_TX_D3N	MIPI DSI negative differential data line transceiver output	26	MIPI_TX_D3P	MIPI DSI positive differential data line transceiver output

2.13 MIPI Camera(CON4, CON5)

Idea3399 features two 26-pin MIPI connectors.

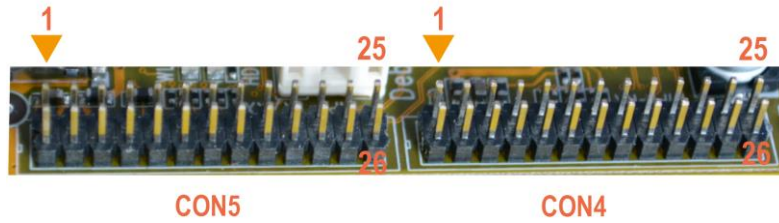

Pin	Signal	Description	Pin	Signal	Description
1	VDD5V	DC 5V	2	VDD5V	DC 5V
3	GND	Ground	4	GND	Ground
5	VCC3V3_SYS	DC 3.3V	6	VCC3V3_SYS	DC 3.3V
7	VDD1V8_DVP	DC 1.8V	8	GND	Ground
9	CIF_PDN0	CIF power ON/OFF	10	3V_GPIO4_D0	3V GPIO
11	MIPI_MCLK0	Camera main clock 0 output	12	I2C2_SCL	I2C serial clock line
13	I2C2_SDA	I2C data line	14	PDM_SCL	Digital microphone clock
15	PDM_SDA	Single-end input for microphone 1 Digital microphone data input	16	GND	Ground
17	MIPI_RX_CLKN	MIPI CSI negative differential clock line transceiver output	18	MIPI_RX_CLKP	MIPI CSI positive differential clock line transceiver output
19	MIPI_RX_D0N	MIPI CSI negative differential data line transceiver output	20	MIPI_RX_D0P	MIPI CSI positive differential data line transceiver output
21	MIPI_RX_D1N	MIPI CSI negative differential data line transceiver output	22	MIPI_RX_D1P	MIPI CSI positive differential data line transceiver output
23	MIPI_RX_D2N	MIPI CSI negative differential data line	24	MIPI_RX_D2P	MIPI CSI positive differential data line

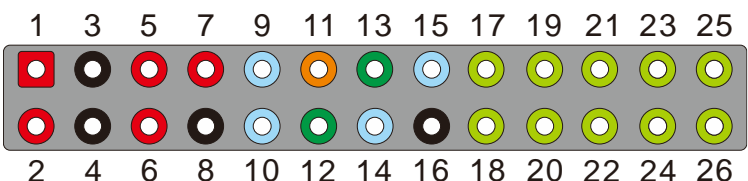
		transceiver output			transceiver output
25	MIPI_RX_D3N	MIPI CSI negative differential data line transceiver output	26	MIPI_RX_D3P	MIPI CSI positive differential data line transceiver output
 <p style="text-align: center;">CON5</p>					
Pin	Signal	Description	Pin	Signal	Description
1	VDD5V	DC 5V	2	VDD5V	DC 5V
3	GND	Ground	4	GND	Ground
5	VCC3V3_SYS	DC 3.3V	6	VCC3V3_SYS	DC 3.3V
7	VDD1V8_DVP	DC 1.8V	8	GND	Ground
9	GPIO1_A0	GPIO	10	GPIO1_A1	GPIO
11	MIPI_MCLK1	Camera main clock 1 output	12	I2C4_SCL	I2C serial clock line
13	I2C4_SDA	Serial data line	14	3V_GPIO4_D3	3V GPIO
15	GPIO3_D6	GPIO	16	GND	Ground
17	MIPI_TX/RX_CLKN	MIPI CSI negative differential clock line transceiver output	18	MIPI_TX/RX_CLKP	MIPI CSI positive differential clock line transceiver output
19	MIPI_TX/RX_D0N	MIPI CSI negative differential data line transceiver output	20	MIPI_TX/RX_D0P	MIPI CSI positive differential data line transceiver output
21	MIPI_TX/RX_D1N	MIPI CSI negative differential data line transceiver output	22	MIPI_TX/RX_D1P	MIPI CSI positive differential data line transceiver output
23	MIPI_TX/RX_D2N	MIPI CSI negative differential data line transceiver output	24	MIPI_TX/RX_D2P	MIPI CSI positive differential data line transceiver output
25	MIPI_TX/RX_D3N	MIPI CSI negative differential data line transceiver output	26	MIPI_TX/RX_D3P	MIPI CSI positive differential data line transceiver output

Currently only con4 supports OV13850 camera con5 does not support.

2.14 Debug (J4)

Idea3399 provides an online debug serial port (UART2). It is used to connect PC and board with the USB-to-serial TTL232 serial cable.

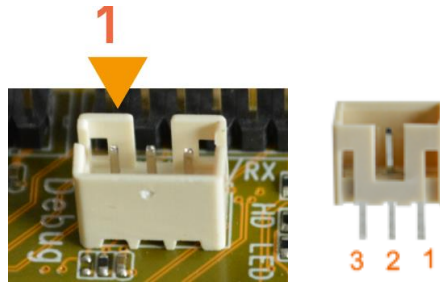

3-pin connector.

Pin	Signal	Description	Pin	Signal	Description
1	UART2DBG_RX	UART serial data input	2	UART2DBG_TX	UART serial data output
3	GND	Ground			

2.15 4G & SIM (CON2, P2)

The 4G module adopts the standard PCI Express® MiniCard form factor (MiniPCIe) and provides global network coverage on the connectivity of LTE. It delivers 50Mbps-up and 100Mbps-down data rates on LTE FDD networks and can also be fully backward compatible with existing UMTS and GSM/GPRS networks. and also provides audio, high-speed data transmission and GPS/GLONASS functionality for your applications.

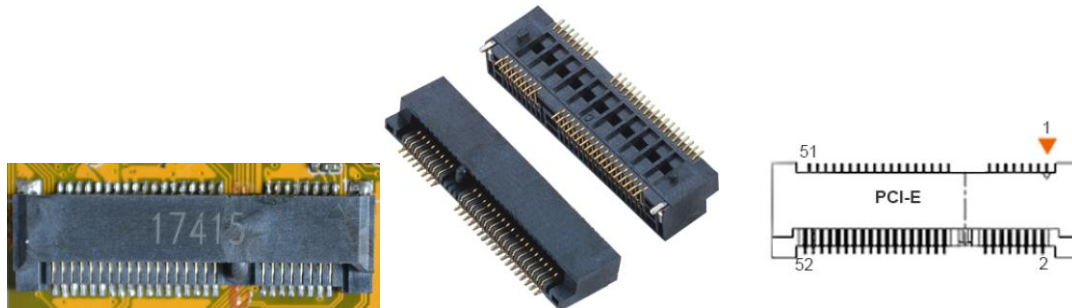

4G Model(EC20) Technical Specifications

- * Form Factor: PCI Express Mini Card
 - * Size: 51 x 30 x 4.9mm
 - * Weight: 9.8g
 - * Bandwidth: 1.4/3/5/10/15/20MHz
 - * Temperature Range: -40°C ~ +80°C
 - * Supply Voltage: 3.0V~3.6V, 3.3V Typical .
- 3GPP TS27.007 and Enhanced AT Commands

CON2					
Pin	Signal	Description	Pin	Signal	Description
1	LOUTP	Line output +	2	3GVCC	DC 3.3V
3	LOUTN	Line output -	4	GND	Ground
5	MIC1P	MIC +	6	NC	Not connect

7	MIC1N	MIC -	8	SIM_VCC	SIM power
9	GND	Ground	10	SIM_DATA	SIM data
11	NC	Not connect	12	SIM_CLK	SIM Clock
13	NC	Not connect	14	SIM_RST	SIM Reset
15	GND	Ground	16	NC	Not connect
17	NC	Not connect	18	GND	Ground
19	NC	Not connect	20	3GVCC	DC 3.3V
21	GND	Ground	22	SPI1_TXD	SPI serial data output
23	NC	Not connect	24	3GVCC	DC 3.3V
25	NC	Not connect	26	GND	Ground
27	GND	Ground	28	NC	Not connect
29	GND	Ground	30	NC	Not connect
31	NC	Not connect	32	NC	Not connect
33	NC	Not connect	34	GND	Ground
35	GND	Ground	36	HOST1_DM	Host data DN
37	GND	Ground	38	HOST1_DP	Host data DP
39	3GVCC	DC 3.3V	40	GND	Ground
41	3GVCC	DC 3.3V	42	LED_RED	LED
43	GND	Ground	44	NC	Not connect
45	NC	Not connect	46	NC	Not connect
47	NC	Not connect	48	NC	Not connect
49	NC	Not connect	50	GND	Ground
51	NC	Not connect	52	3GVCC	DC 3.3V

P2 is an auto pop-up SIM card slot which is compatible to the Nano SIM Card and can be used for wireless transmission with a 4G module.

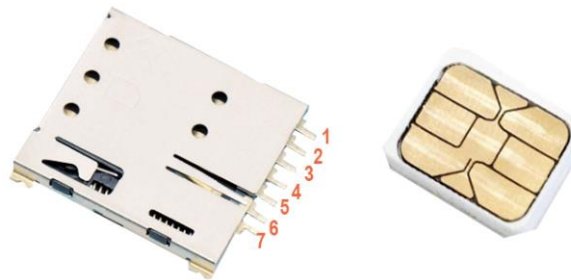

Nano SIM Card slot (P2)					
Pin	Signal	Description	Pin	Signal	Description
1	SIM_CLK	Clock signal	2	SIM_DATA	Send/Receiver data I/O control
3	SIM_RST	Reset signal	4	SIM_VCC	Power supply
5	SIM_VCC	Power supply	6	GND	Ground
7	NC	Not connect			

2.16 SATA (CON3)

M2_NVME_H3.2MM

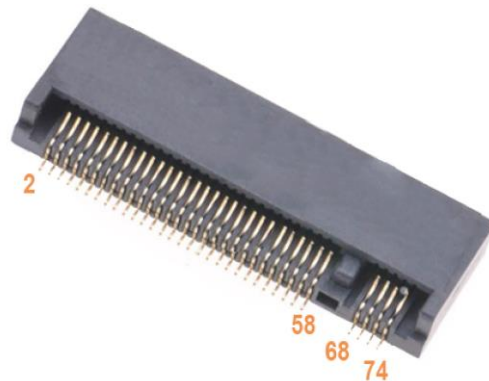
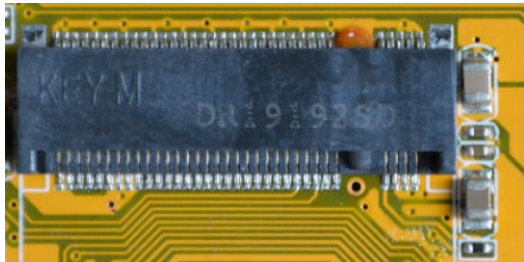

Pin	Signal	Description	Pin	Signal	Description
1	GND	Ground	2	PCIE_3V3	DC 3.3V
3	GND	Ground	4	PCIE_3V3	DC 3.3V
5	NC	Not connect	6	NC	Not connect
7	NC	Not connect	8	NC	Not connect
9	GND	Ground	10	DAS	Connect to led
11	NC	Not connect	12	PCIE_3V3	DC 3.3V
13	NC	Not connect	14	PCIE_3V3	DC 3.3V
15	GND	Ground	16	PCIE_3V3	DC 3.3V
17	NC	Not connect	18	PCIE_3V3	DC 3.3V
19	NC	Not connect	20	NC	Not connect
21	GND	Ground	22	NC	Not connect
23	NC	Not connect	24	NC	Not connect
25	NC	Not connect	26	NC	Not connect
27	GND	Ground	28	NC	Not connect
29	PCIE_TX1_N	PCIe differential data output signal	30	NC	Not connect
31	PCIE_TX1_P	PCIe differential data output signal	32	NC	Not connect
33	GND	Ground	34	NC	Not connect
35	PCIE_RX1_N	PCIe differential data input signal	36	NC	Not connect
37	PCIE_RX1_P	PCIe differential data input signal	38	PCIE_DEVSLP	Device Sleep
39	GND	Ground	40	NC	Not connect
41	PCIE_TX0_N	PCIe differential data output signal	42	NC	Not connect
43	PCIE_TX0_P	PCIe differential data output signal	44	NC	Not connect
45	GND	Ground	46	NC	Not connect

47	PCIE_RX0_N	PCIe differential data input signal	48	NC	Not connect
49	PCIE_RX0_P	PCIe differential data input signal	50	PCIE_PERST#	PCIE Power reset
51	GND	Ground	52	NC	Not connect
53	PCIE_REF_CLK_N	100MHz differential reference clock out for PCIe peripheral	54	PEWAKE#	PCIE Wake
55	PCIE_REF_CLK_P	100MHz differential reference clock out for PCIe peripheral	56	NC	Not connect
57	GND	Ground	58	NC	Not connect
67	NC	Not connect	68	RTC_CLKO_WI FI	External low power clock input
69	NC	Not connect	70	PCIE_3V3	DC 3.3V
71	GND	Ground	72	PCIE_3V3	DC 3.3V
73	GND	Ground	74	PCIE_3V3	DC 3.3V
75	GND	Ground			

2.17 Micro SD (J1)

The Micro SD card is used as an external storage device. The MMC controller interface supports up to 4-bit transfer modes. MMC is always accessible through the carrier board interface. It support hot-plug.

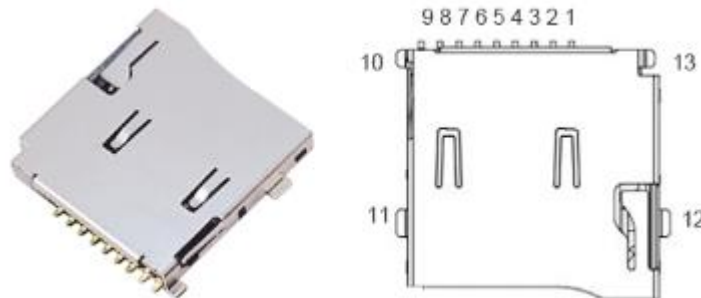

Pin	Signal	Description	Pin	Signal	Description
1	SDMMC_D2	SD/MMC data2	2	SDMMC_D3	SD/MMC data3
3	SDMMC_CMD	SD/MMC command signal	4	VCC3V3_S0	3.3V
5	SDMMC_CLK	SD/MMC clock	6	GND	Ground
7	SDMMC_D0	SD/MMC data0	8	SDMMC_D1	SD/MMC data1
9	SDMMC0_DET_L	SD/MMC detect signal	10	GND	Ground
11	GND	Ground	12	GND	Ground

2.18 WiFi&Bluetooth (U8)

The AP6356S is a low-power consumption module which has incorporated Wi-Fi and Bluetooth into one chip. The wireless module complies with IEEE 802.11 a/b/g/n/ac 2x2 MIMO standard and it can achieve up to a speed of 867Mbps with dual stream in 802.11n to connect the wireless LAN. The integrated module provides SDIO interface for WiFi, UART / PCM interface for Bluetooth.

Features

- 802.11a/b/g/n/ac dual-band radio with virtual-simultaneous dual-band operation
- Dual-stream spatial multiplexing up to 867 Mbps data rate.
- Supports 20, 40, 80 MHz channels with optional SGI(256 QAM modulation)
- Supports IEEE 802.11 ac/n beam forming.
- Supports IEEE 802.15.2 external coexistence interface to optimize bandwidth utilization with other co-located wireless technologies such as LTE, GPS, or WiMAX.
 - Supports standard SDIO interfaces.
- BT host digital interface:
 - HCI UART (up to 4 Mbps)
 - PCM for audio data
- Complies with Bluetooth Core Specification Version 4.1 with provisions for supporting future specifications. With Bluetooth Class 1 or Class2 transmitter operation.
- Supports extended synchronous connections



Pin	Signal	Description	Pin	Signal	Description
1	GND	Ground	2	WIFI/BT_ANT	RF I/O port0
3	GND	Ground	4	GND	Ground
5	GND	Ground	6	GND	Ground
7	GND	Ground	8	GND	Ground
9	WL_ANT	RF I/O port0	10	GND	Ground
11	GND	Ground	12	NC	Not connect
13	XTAL_IN	External Crystal in	14	XTAL_OUT	External Crystal out
15	WIFI_REG_ON_H	Low asserting reset for WiFi core	16	WIFI_HOST_WAKE_L	WLAN to wake-up HOST
17	SDIO_CMD	SDIO command	18	SDIO_CLK	SDIO clock

19	SDIO_D3	SDIO data	20	SDIO_D2	SDIO data
21	SDIO_D0	SDIO data	22	SDIO_D1	SDIO data
23	GND	Ground	24	NC	Not connect
25	VIN_LDO	Internal Buck voltage generation pin	26	VIN_LDO_OUT	Internal Buck voltage generation pin
27	BT_PCM_SYNC	PCM sync signal	28	BT_PCM_IN	PCM data input
29	BT_PCM_OUT	PCM Data output	30	BT_PCM_CLK	PCM clock
31	RTC_CLKO_WIFI	External Low Power Clock input (32.768KHz)	32	GND	Ground
33	NC	Not connect	34	VDDIO_WL	I/O Voltage supply input
35	NC	Not connect	36	VCC_WL	Main power voltage source input
37	NC	Not connect	38	BT_REG_ON_H	Low asserting reset for Bluetooth core
39	GND	Ground	40	UART0_RXD	Bluetooth UART interface
41	UART0_TXD	Bluetooth UART interface	42	UART0_CTS	Bluetooth UART interface
43	UART0_RTS	Bluetooth UART interface	44	NC	Not connect
45	NC	Not connect	46	NC	Not connect
47	NC	Not connect	48	NC	Not connect
49	BT_WAKE_L	HOST wake-up Bluetooth device	50	BT_HOST_WAKE_L	Bluetooth device to wake-up HOST

2.19 RTC (BT1)



The backup battery (3V) is used to ensure the RTC (frequency 32.768KHz) is still able to work after power off. Cell model: CR1220.

Pin	Signal	Description	Pin	Signal	Description
1	VCC-RTC	3V battery	2	GND	Ground

2.20 Infrared Receiver(U3)

Idea3399 features a small Infrared Receiver, with central frequency 38KHz.

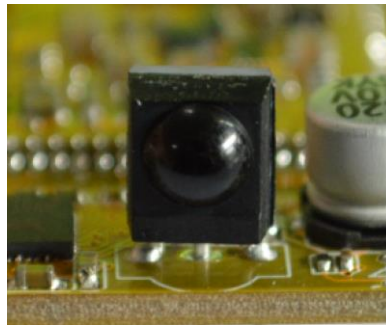

Pin	Signal	Description	Pin	Signal	Description
1	PWM3_IRIN	IR in	2	GND	Ground
3	VCC3V3_SYS	DC 3.3V			

3 Product Configurations

3.1 Standard Contents

NO.	Item	Qty. (PCS)	Description
1	Idea3399 board	1	Standard Content (4GB RAM, 8GB eMMC)
2	TF Card / CD-ROM	1	Android BSP, Documents, tools, Schematic Drawing, Datasheets
3	Ethernet cable	1	
4	Serial Cable	1	CP2102
5	USB Cable	1	USB3.1 Type-C
6	Power adaptor	1	5V/3A DC

3.2 Optional Parts

- USB camera Module
- LCD Module (7-inch /10.1-inch MIPI panel)
- 4G Module
- SATA module